

# C18 Series Photoelectric Sensors



## M18 (18 mm) metal – DC

- 36 models available
- Diffuse, Polarized reflective, Through-beam, and Diffuse with background suppression models
- Long operating distances
- Scratch resistant and easy-to-clean glass lens
- Adjustable sensitivity (diffuse models only)
- Axial cable or 12 mm quick-disconnect models
- Complete overload protection
- IP67 rated

### Cables and Accessories

Cables and accessories can be found starting on page 19–65

**C18 Series Photoelectric Sensor Selection Chart**

Part Number	Sensing Range	Output State	Optics	Logic	Connection	Wiring	Dimensions	Characteristic Curves	Price
<b>Diffuse</b>									
<b>C18D-ON-1A</b>	Up to 600mm (23.62 in)	1 N.O. and 1 N.C.	Axial	NPN	2m (6.5') axial cable	Diagram 3	Figure 1	Chart 5	<--->
<b>C18D-OP-1A</b>		1 N.O. and 1 N.C.	Axial	PNP	2m (6.5') axial cable	Diagram 4	Figure 1	Chart 5	<--->
<b>C18D-ON-1E</b>		1 N.O. and 1 N.C.	Axial	NPN	M12 (12mm) connector	Diagram 3	Figure 2	Chart 5	<--->
<b>C18D-OP-1E</b>		1 N.O. and 1 N.C.	Axial	PNP	M12 (12mm) connector	Diagram 4	Figure 2	Chart 5	<--->
<b>C18D-ON-2A</b>		1 N.O. and 1 N.C.	Right-angle	NPN	2m (6.5') axial cable	Diagram 3	Figure 3	Chart 6	<--->
<b>C18D-OP-2A</b>		1 N.O. and 1 N.C.	Right-angle	PNP	2m (6.5') axial cable	Diagram 4	Figure 3	Chart 6	<--->
<b>C18D-ON-2E</b>		1 N.O. and 1 N.C.	Right-angle	NPN	M12 (12mm) connector	Diagram 3	Figure 4	Chart 6	<--->
<b>C18D-OP-2E</b>		1 N.O. and 1 N.C.	Right-angle	PNP	M12 (12mm) connector	Diagram 4	Figure 4	Chart 6	<--->
<b>Diffuse with background suppression</b>									
<b>C18B-AN-1A</b>	10-120mm (0.39 to 4.72 in)	N.O.	Axial	NPN	2m (6.5') axial cable	Diagram 1	Figure 1	Chart 1	<--->
<b>C18B-AP-1A</b>			Axial	PNP	2m (6.5') axial cable	Diagram 2	Figure 1	Chart 1	<--->
<b>C18B-AN-1E</b>			Axial	NPN	M12 (12mm) connector	Diagram 1	Figure 2	Chart 1	<--->
<b>C18B-AP-1E</b>			Axial	PNP	M12 (12mm) connector	Diagram 2	Figure 2	Chart 1	<--->
<b>C18B-AN-2A</b>	10-120mm (0.39 to 4.72 in)	N.O.	Right-angle	NPN	2m (6.5') axial cable	Diagram 1	Figure 3	Chart 2	<--->
<b>C18B-AP-2A</b>			Right-angle	PNP	2m (6.5') axial cable	Diagram 2	Figure 3	Chart 2	<--->
<b>C18B-AN-2E</b>			Right-angle	NPN	M12 (12mm) connector	Diagram 1	Figure 4	Chart 2	<--->
<b>C18B-AP-2E</b>			Right-angle	PNP	M12 (12mm) connector	Diagram 2	Figure 4	Chart 2	<--->
<b>Polarized reflective *Receivers include one round (84mm dia.) reflector. Purchase additional reflectors separately.</b>									
<b>C18P-AN-1A</b>	Up to 2m (6.6 ft)	N.O.	Axial	NPN	2m (6.5') axial cable	Diagram 1	Figure 1	Chart 3	<--->
<b>C18P-AP-1A</b>			Axial	PNP	2m (6.5') axial cable	Diagram 2	Figure 1	Chart 3	<--->
<b>C18P-AN-1E</b>			Axial	NPN	M12 (12mm) connector	Diagram 1	Figure 2	Chart 3	<--->
<b>C18P-AP-1E</b>			Axial	PNP	M12 (12mm) connector	Diagram 2	Figure 2	Chart 3	<--->
<b>C18P-AN-2A</b>	Up to 2m (6.6 ft)	N.O.	Right-angle	NPN	2m (6.5') axial cable	Diagram 1	Figure 3	Chart 4	<--->
<b>C18P-AP-2A</b>			Right-angle	PNP	2m (6.5') axial cable	Diagram 2	Figure 3	Chart 4	<--->
<b>C18P-AN-2E</b>			Right-angle	NPN	M12 (12mm) connector	Diagram 1	Figure 4	Chart 4	<--->
<b>C18P-AP-2E</b>			Right-angle	PNP	M12 (12mm) connector	Diagram 2	Figure 4	Chart 4	<--->
<b>Through-beam **Purchase one receiver and one emitter for a complete set.</b>									
<b>C18R-ON-1A</b>	Up to 6m (19.7 ft)	1 N.O. and 1 N.C.	Axial	NPN	2m (6.5') axial cable	Diagram 3	Figure 1	Chart 7	<--->
<b>C18R-OP-1A</b>			Axial	PNP	2m (6.5') axial cable	Diagram 4	Figure 1	Chart 7	<--->
<b>C18R-ON-1E</b>			Axial	NPN	M12 (12mm) connector	Diagram 3	Figure 2	Chart 7	<--->
<b>C18R-OP-1E</b>			Axial	PNP	M12 (12mm) connector	Diagram 4	Figure 2	Chart 7	<--->
<b>C18E-00-1A</b>	Receiver dependent	Receiver dependent	Axial	Receiver dependent	2m (6.5') axial cable	Diagram 5	Figure 5	Chart 7	<--->
<b>C18E-00-1E</b>			M12 (12mm) connector		Diagram 5	Figure 6	Chart 7	<--->	
<b>C18R-ON-2A</b>	Up to 6m (19.7 ft)	1 N.O. and 1 N.C.	Right-angle	NPN	2m (6.5') axial cable	Diagram 3	Figure 3	Chart 8	<--->
<b>C18R-OP-2A</b>			Right-angle	PNP	2m (6.5') axial cable	Diagram 4	Figure 3	Chart 8	<--->
<b>C18R-ON-2E</b>			Right-angle	NPN	M12 (12mm) connector	Diagram 3	Figure 4	Chart 8	<--->
<b>C18R-OP-2E</b>			Right-angle	PNP	M12 (12mm) connector	Diagram 4	Figure 4	Chart 8	<--->
<b>C18E-00-2A</b>	Receiver dependent	Receiver dependent	Right-angle	Receiver dependent	2m (6.5') axial cable	Diagram 5	Figure 7	Chart 8	<--->
<b>C18E-00-2E</b>			Right-angle		M12 (12mm) connector	Diagram 5	Figure 8	Chart 8	<--->

# C18 Series Photoelectric Sensors

Specifications	Diffuse Models	Diffuse Models with Background Suppression	Reflective Models	Through-beam Models
<b>Type</b>	Diffuse reflection	Diffuse reflection with background suppression	Polarized reflection	Through-beam <sup>1</sup>
<b>Sensing Distance</b>	600 mm (23.62in) <sup>2</sup>	10 to 120 mm (0.39 to 4.72 in) <sup>3</sup>	2 m (6.6 ft)	6 m (19.7 ft)
<b>Emission</b>	LED red (660nm)	LED red (660nm)	LED red polarized (660 nm)	LED red (660nm)
<b>Differential Travel</b>	≤10%			
<b>Operating Voltage</b>	10-36 VDC			
<b>Ripple</b>	≤20%			
<b>Power Consumption</b>	20 mA	25 mA	15 mA	Receiver: 10 mA Emitter: 15 mA
<b>Load Current</b>	≤200 mA			
<b>Leakage Current</b>	≤10μ A			
<b>Voltage Drop</b>	≤2.0 V			
<b>Output Type</b>	NPN or PNP; 1 N.O. and 1 N.C.	NPN or PNP; N.O. only	NPN or PNP; N.O. only	NPN or PNP; 1 N.O. and 1 N.C.
<b>Switching Frequency</b>	1kHz	500Hz	1kHz	1kHz
<b>(tv) Time Delay Before Availability</b>	60ms	20ms	20ms	20ms
<b>Input Voltage Transients Protection</b>	Up to 36 VDC			
<b>Input Power Polarity Reversal Protection</b>	Yes			
<b>Output Power Short-Circuit Protection</b>	Yes (switch autoresets after overload is removed)			
<b>Temperature Range</b>	-25° to +55°C (-13° to 131°F)			
<b>Temperature Drift</b>	0.5% per °C			
<b>Interference to External Light</b>	5,000 lux (incandescent lamp) 10,000 lux (sunlight)			
<b>Protection Degree (DIN 40050)</b>	IEC IP67			
<b>LED Indicators</b>	Yellow (output state, output energized), green (excess light indication). Emitter has no LED.			
<b>Housing Material</b>	Chrome-plated brass			
<b>Lens Material</b>	Glass			

**Notes:** <sup>1</sup>Through-beam sensors must be used in pairs consisting of one receiver and one emitter. <sup>2</sup>With 200x200mm white matte paper. <sup>3</sup>With 100x100mm white matte paper.

## Wiring diagrams

**Warning: These products are not safety sensors and are not suitable for use in personal safety applications.**

**Diagram 1**

NPN Output

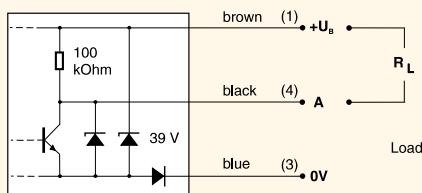
**Diagram 2**

PNP Output

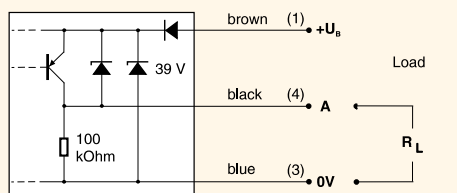
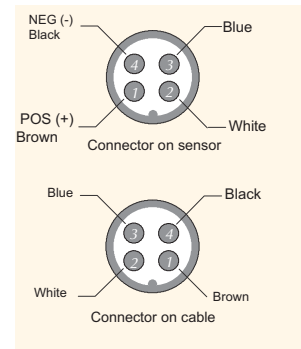
**M12 Connector**

**Diagram 3**

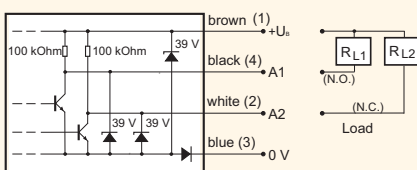
4-Wire NPN Output

**Diagram 4**

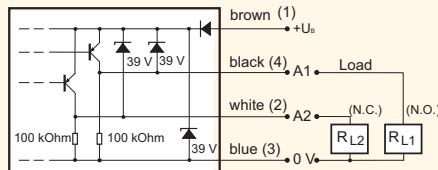
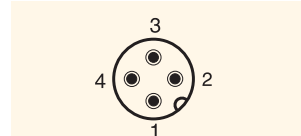
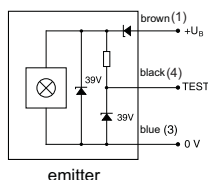
4-Wire PNP Output

**4-Wire Pinouts**

**Diagram 5**

# C18 Series Photoelectric Sensors

## Dimensions (mm)

Figure 1

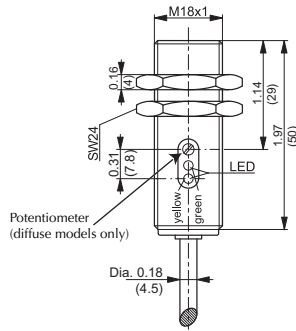

Figure 2

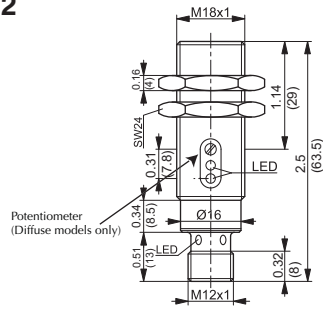

Figure 3

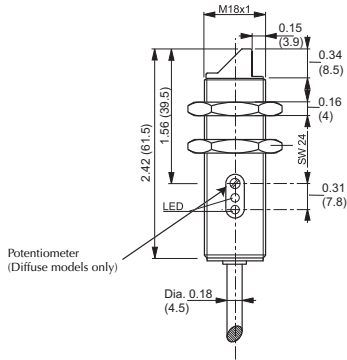

Figure 4

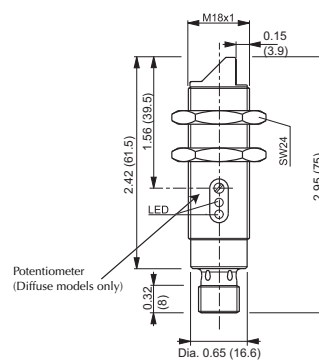

Figure 5

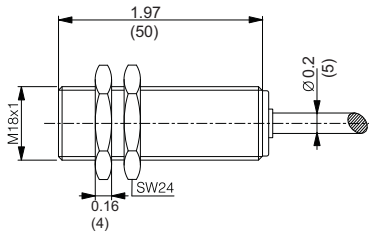

Figure 6

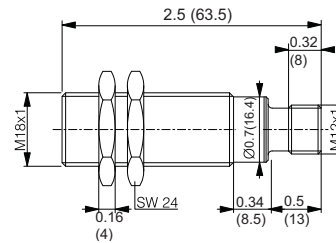

Figure 7

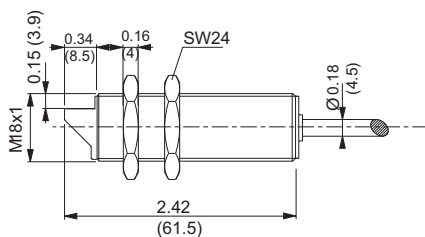
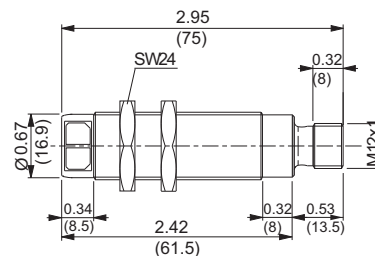

Figure 8



Note: Dimensions are in inches (millimeters).

# C18 Series Photoelectric Sensors

## Characteristic Curves

Chart 1

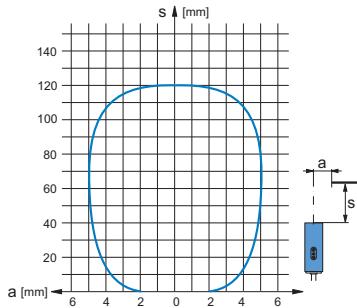

Chart 2

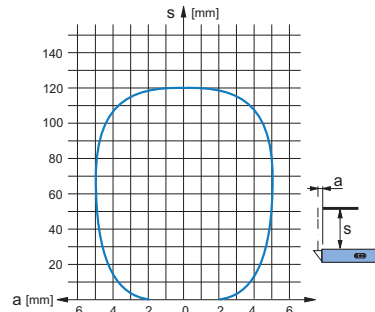

Chart 3

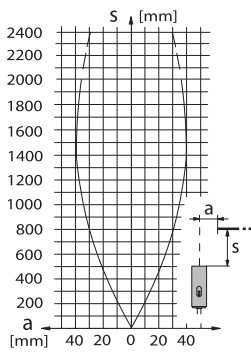

Chart 4

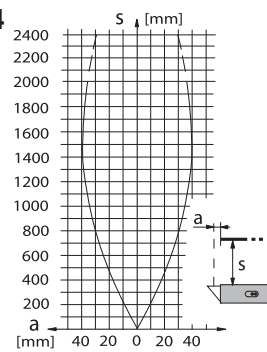

Chart 5

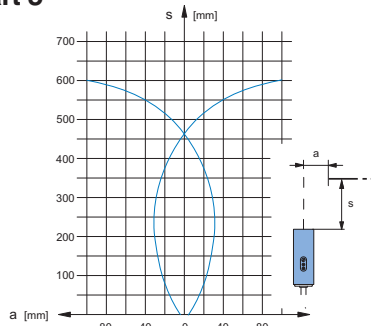

Chart 6

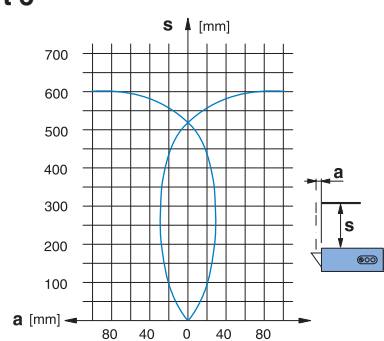

Chart 7

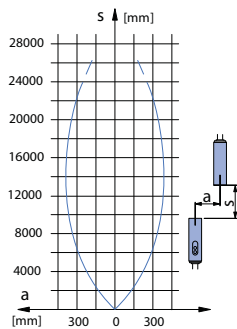
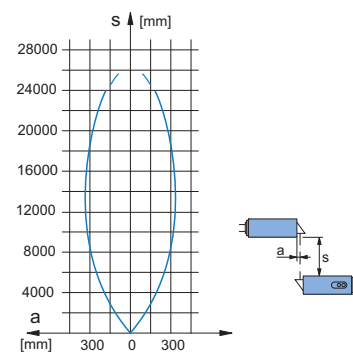

Chart 8



PLC  
Overview

DL05/06  
PLC

DL105  
PLC

DL205  
PLC

DL305  
PLC

DL405  
PLC

Field I/O

Software

C-more  
HMIs

Other HMI

AC Drives

Motors

Steppers/  
Servos

Motor  
Controls

Proximity  
Sensors

Photo  
Sensors

Limit  
Switches

Encoders

Current  
Sensors

Pushbuttons/  
Lights

Process

Relays/  
Timers

Comm.

TB's &  
Wiring

Power

Circuit  
Protection

Enclosures

Appendix

Part Index