

## Data sheet | Item number: 750-975

RJ-45 connector; IP20; ETHERNET 10/100 Mbit/s

[www.wago.com/750-975](http://www.wago.com/750-975)

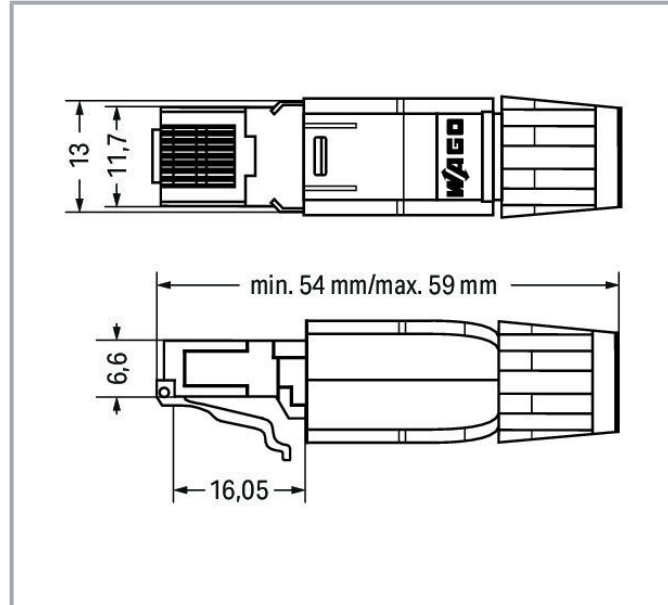
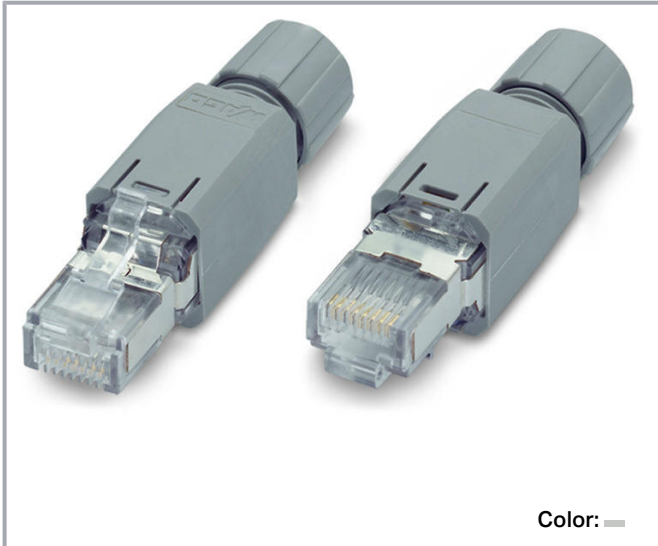

### Pin assignment TIA-568A

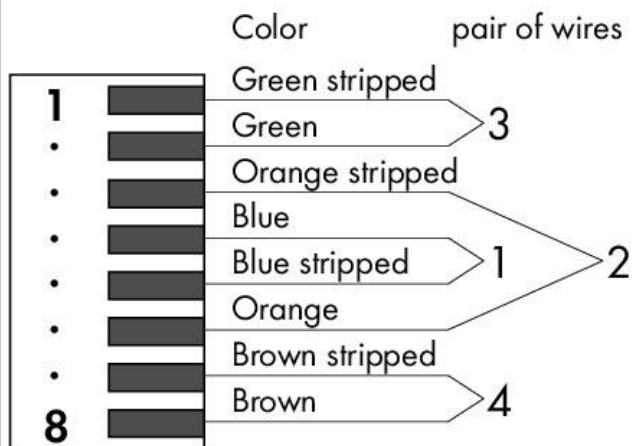

### Item description

Versatile RJ-45 connector for industrial, office and building wiring applications.

This compact RJ-45 ETHERNET Connector uses IDC technology for easy field assembly.

Subject to changes. Please also observe the further product documentation!

WAGO Corporation  
Germantown, WI 53022  
Phone: 1-800-DIN-RAIL (346-7245) | Fax: (262) 255-6222  
Email: [info.us@wago.com](mailto:info.us@wago.com) | Web: [www.wago.us](http://www.wago.us)

Do you have any questions about our products?  
We are always happy to take your call at (262) 255-6222 or 1 800-DIN-RAIL.



Conductor termination is performed without any tools. The connector is compliant with all required standards. Large conductor cross-sections can also be connected. The connector complies with Category 5e.

## Data

### Technical data

Connection type	RJ-45 plug
Number of poles	8
Cable connection direction to mating direction	0°
Communication/fieldbus	Ethernet
Code	TIA-568A
Baud rate	-
Insulation resistance	(100 V) > 1 GΩ

### Connection data

Connection type (1)	IDC contact
Solid conductor	0.13 ... 0.24 mm <sup>2</sup> / 26/1 ... 23/1 AWG
Stranded conductor 2	0.14 ... 0.36 mm <sup>2</sup> / 26/7 ... 22/7 AWG

### Physical data

Width	14 mm
Height	14 mm
Depth	59 mm

### Mechanical data

Shield	Brass (CuZn); hot-dip tinned 3 μm; Shield contact: large surface >180°
Connection requirement (permissible cable type)	Cat. 5e
Connectable sheathed cable diameter	4.5 ... 8 mm
Housing material	Plastic
Contact material	Bronze (CuSn6)
Contact plating	> 1.2 μm gold over 1.2 μm nickel
Mating cycles (max.)	1,000
Weight	12 g
Color	light gray

Subject to changes. Please also observe the further product documentation!

## Environmental requirements

Surrounding air temperature (operation)	-20 ... 70 °C
Surrounding air temperature (storage)	-40 ... 70 °C
Protection type	IP20
Relative humidity (without condensation)	95 %
Vibration resistance	4g per IEC 60068-2-6
Standards/Specifications	Basic standard: IEC 60603-7 RJ-45 Category 5 CD ISO/IEC 11801: 2002 EN 50173: 2002 EIA/TIA 568A: 2002

## Commercial data

Product Group	15 (Remote I/O)
Packaging type	Karton
Country of origin	CH
GTIN	4045454482480
Customs tariff number	8536694040

## Approvals / Certificates



### Ship Approvals

Logo	Approval	Additional Approval Text	Certificate name
	<b>ABS</b> American Bureau of Shipping	-	19- HG1821926
	<b>BV</b> Bureau Veritas S.A.	-	30389/B0 BV
	<b>DNV GL</b> Det Norske Veritas, Germanischer Lloyd	-	TAA0000194
	<b>KR</b> Korean Register of Shipping	-	KR HMB05880- AC001
	<b>LR</b>	-	02/20026 (E6)

Subject to changes. Please also observe the further product documentation!



Lloyds Register

	<b>NK</b> Nippon Kaiji Kyokai	-	TA17255M
	<b>PRS</b> Polski Rejestr Statków	-	TE/2236 /880590/19
	<b>RINA</b> RINA Germany GmbH	-	ELE066419XG

**UL-Approvals**

Logo	Approval	Additional Approval Text	Certificate name
	<b>UL</b> Underwriters Laboratories Inc.	UL 1977	E345416

**Downloads  
Documentation**

**Manual**

System Manual WAGO I/O System 750 / 753 Decentralized Automation Technology	V 3.0.2 Apr 27, 2021	pdf 6.6 MB	Download
--	-------------------------	---------------	----------

**Bid Text**

750-975 X81 - Datei	Feb 19, 2019	xml 5.5 kB	Download
750-975 doc - Datei	Oct 6, 2017	doc 27.6 kB	Download

**System Description**

Overview on WAGO-I/O-SYSTEM 750 approvals	pdf	Download
---	-----	----------

Subject to changes. Please also observe the further product documentation!

WAGO Corporation  
Germantown, WI 53022  
Phone: 1-800-DIN-RAIL (346-7245) | Fax: (262) 255-6222  
Email: [info.us@wago.com](mailto:info.us@wago.com) | Web: [www.wago.us](http://www.wago.us)

Do you have any questions about our products?  
We are always happy to take your call at (262) 255-6222 or 1 800-DIN-RAIL.



780.2 kB

---

### Additional Information

Disposal; Electrical and electronic equipment, Packaging	V 1.0.0	pdf 265.8 kB	Download
--	---------	-----------------	----------

---

### CAD files

#### CAE data

EPLAN Data Portal 750-975	URL	Download
WSCAD Universe 750-975	URL	Download

---

### Environmental Product Compliance

#### Compliance Search

Environmental Product Compliance 750-975 ETHERNET RJ-45 connector, IP20; ETHERNET 10/100 Mbit/s; for field assembly	URL	Download
--	-----	----------

---

### Installation Notes

Subject to changes. Please also observe the further product documentation!